

HOW TO REMOVE YOUR OLD UPHOLSTERY

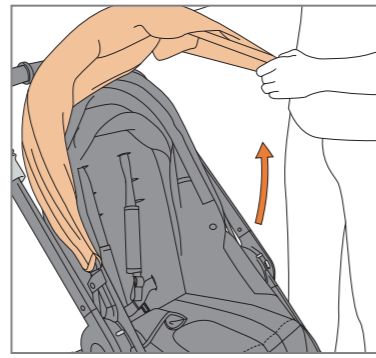

1. Unclip the sunshade attachments and remove sunshade.

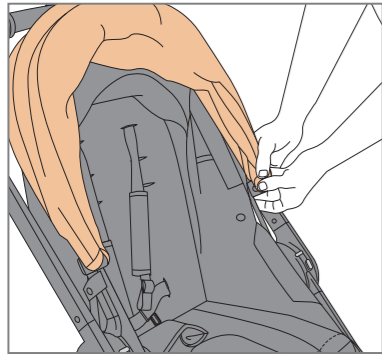
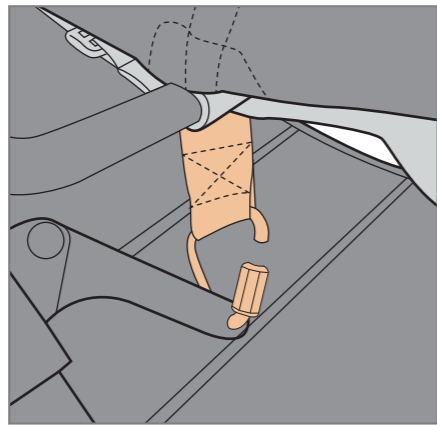
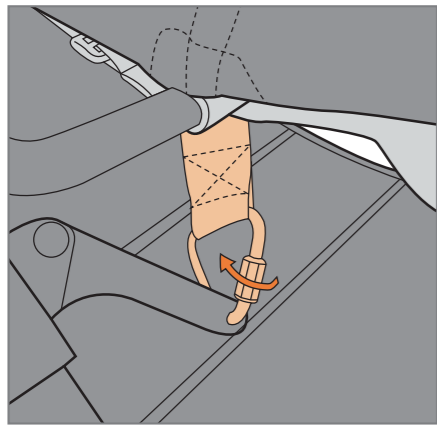

2. Use a small wrench to open one of the screw gate triangles and remove one of the fold strap ends.

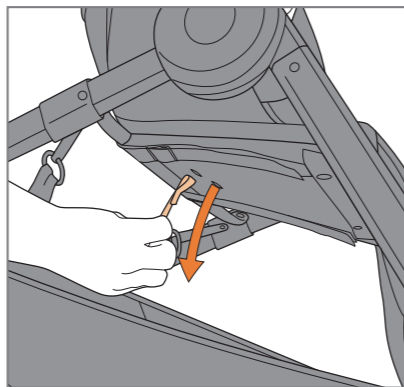
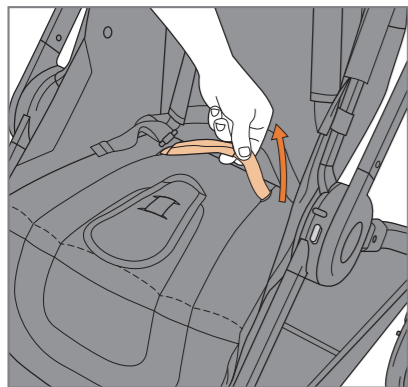

3. Pull the fold strap through both openings in the seat bottom.

HOW TO REMOVE YOUR OLD UPHOLSTERY

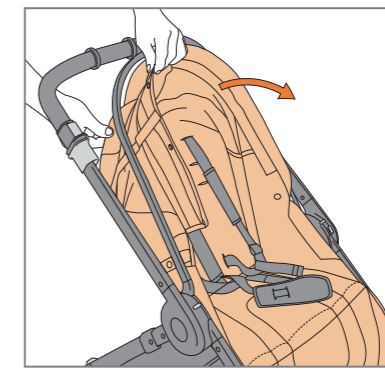
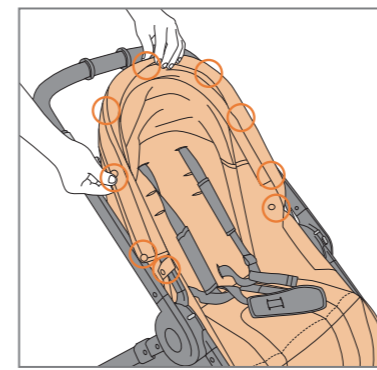

4. Undo the seat back snaps (there are 9 snaps in total).

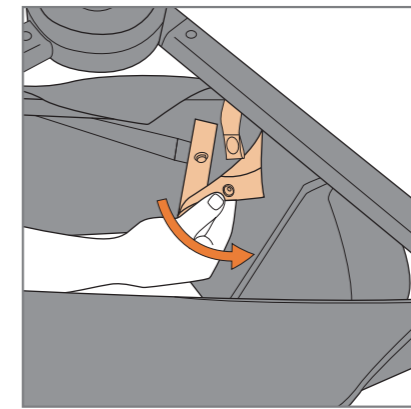
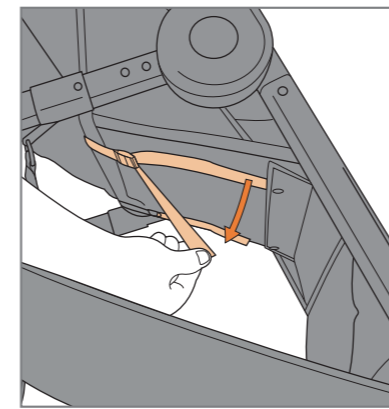

5. Undo velcro of straps underneath the seat bottom.

6. Undo velcro and snaps near front of seat bottom.

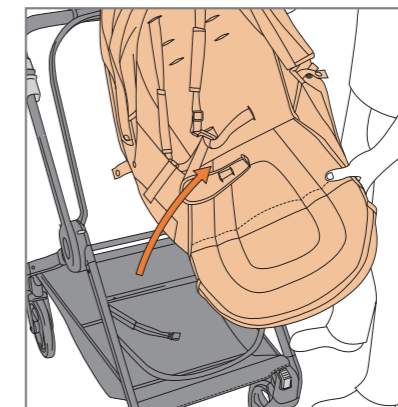
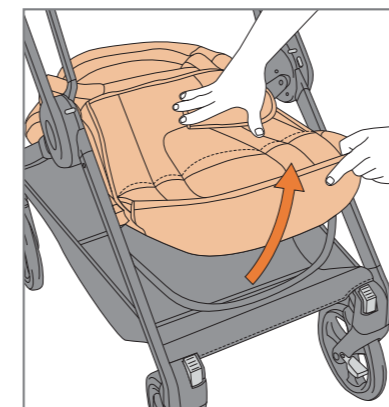

7. Pull footrest fabric and remove old upholstery.

HOW TO INSTALL YOUR NEW UPHOLSTERY

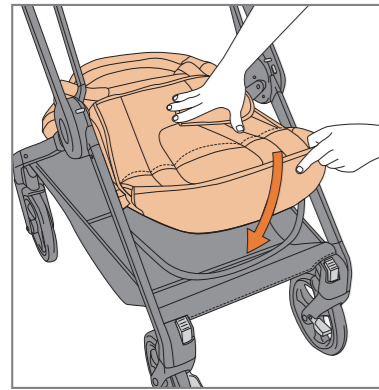

8. Place new upholstery on stroller and fasten footrest fabric around the footrest tube.

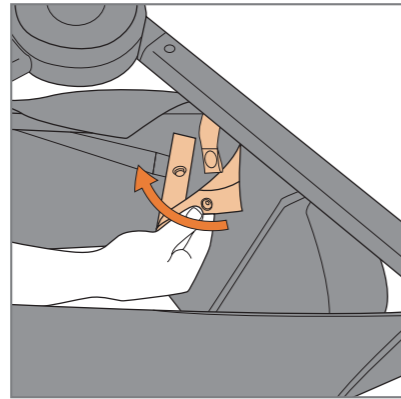

9. Attach velcro and snaps near front of seat bottom.

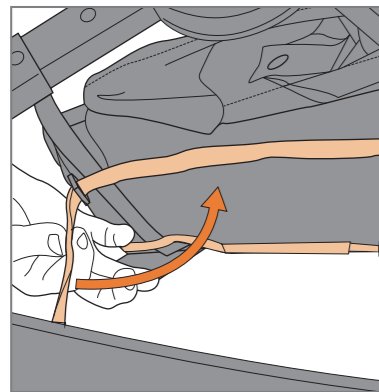

10. Feed straps underneath the seat bottom through the plastic loops near the rear of the seat bottom and fasten the velcro strips.

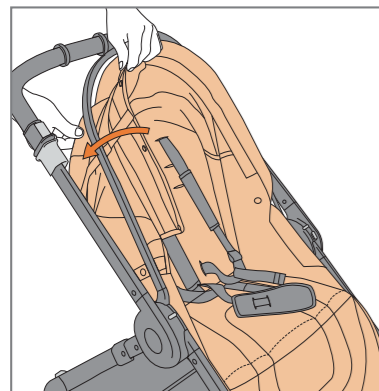
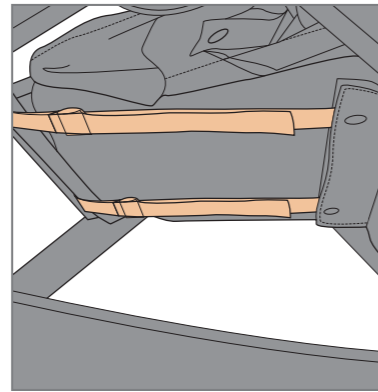

11. Attach the seat back snaps (there should be 9 snaps in total).

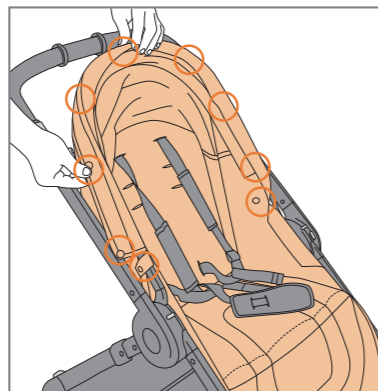

HOW TO INSTALL YOUR NEW UPHOLSTERY

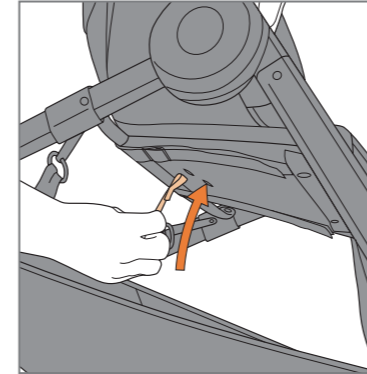

12. Feed the fold strap through both openings in the seat bottom. Ensure the strap is not twisted.

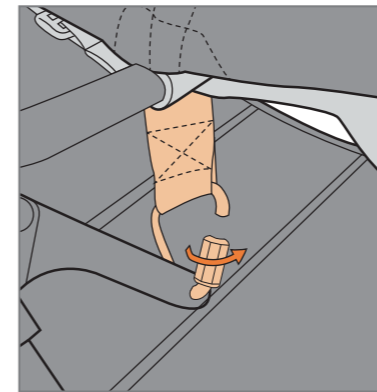
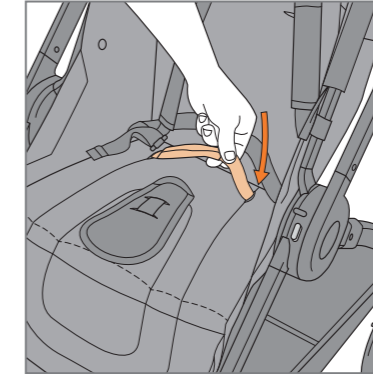

13. Reattach free end of the fold strap and use a small wrench to fully close the screw gate triangle.

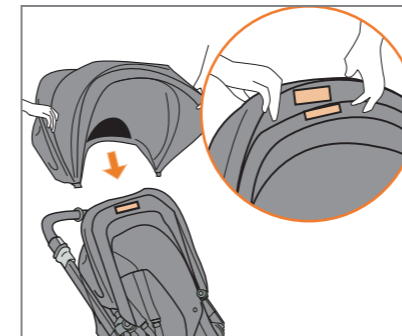

14. Attach the sunshade middle velcro to the top of the seat backrest. The sunshade attachment is securely attached when clamped around the seat backrest tube and sunshade attachment bumps are aligned with the corresponding holes in the tube. First, clamp the attachment around the tube. Then slide the attachment up and down until the bumps settle into the holes in the seat backrest tube.

